

TALL CYLINDER

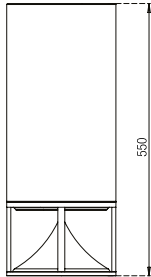
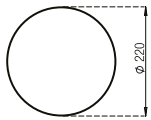

FULL RANGE SOUND OUTPUT

Speaker type
6" dual-concentric speaker

Nominal impedance
8 Ω

Crossover
two way on board

Frequency range
55-20.000 Hz (-6dB)

Sensitivity (1W-1m)
89 dB

Speaker Peak Power
300W

Speaker RMS Power
150W

Recommended amplifier power
200W (Class D)

SUBWOOFER SOUND OUTPUT

Speaker type
6" Woofer

Nominal impedance
8 Ω

Crossover
no crossover on board - DSP needed (HP 35 Hz 12dB/oct min; LP 120 Hz 12 dB/oct min)

Frequency range
50-150 Hz (-6dB)

Sensitivity (1W-1m)
89 dB

Speaker Peak Power
300W

Speaker RMS Power
150W

Recommended amplifier power
200W (Class D)

LAMPS SPECS (optional)

Light source
LED module: 1x7W

Rated output
7W

Power supply
90-260V

SPECIFICATIONS

Material
marbles, travertine, granite, Tuscan terracotta, wood, concrete

Base material
stainless steel, brass, aluminum and painted graphite

Dimensions
220 x 550 mm

Weight
25 kg (marble)

Unpacking: to remove the Cylinder from the shipping box carefully follow these steps

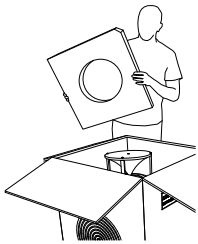

1. Remove the upper part of the packaging, to release the base of the module.



2. Hold the metal base firmly and gently pull the Cylinder out of the box.

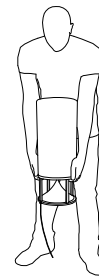

3. Turn the module and place into position, it is ready to be installed.

Output cable: the standard output cable for the Cylinder's bases is vertical coming out from below the base. The cable can run horizontally (rubber feet) or underground.

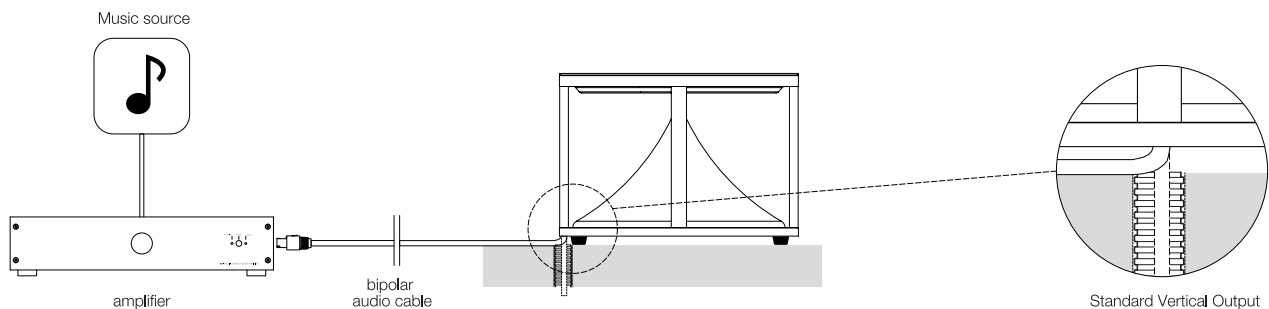

Lighting Mood Output (optional): the Lighting Mood bases have two cables coming out from below, the acoustic and the electrical one; refer to the following scheme for installation:

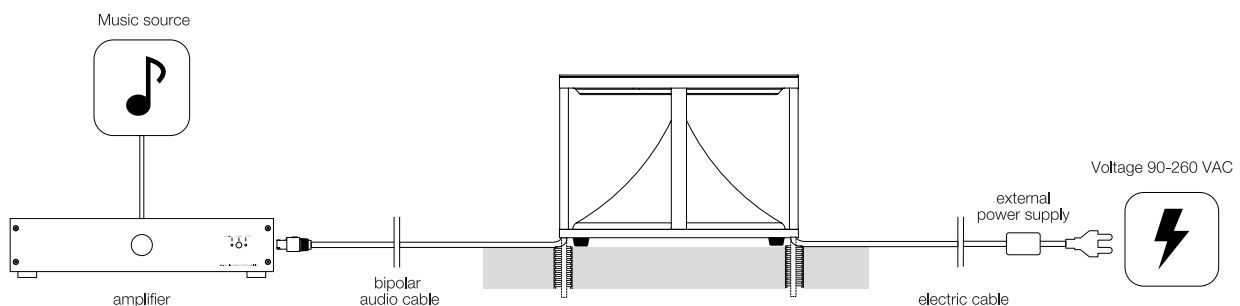

Diffusion and directionality: Cylinders are characterized by a dual-concentric 6" transducer, where the mid-woofer and the tweeter share the same axis, to achieve a virtually punctiform source, linear and time coherent, which, combined with the deflection system, ensures an ideal omnidirectional emission. The result is a very natural sound, not constrained to any fixed and obligated listening positions, with an amazing quality and clarity unusual in outdoor environments. It is recommended to place these modules, either indoor or outdoor, directly on the floor; indoor it is usually recommendable to position them at least 0,6-1 meter from each wall to enhance soundstage and clarity.

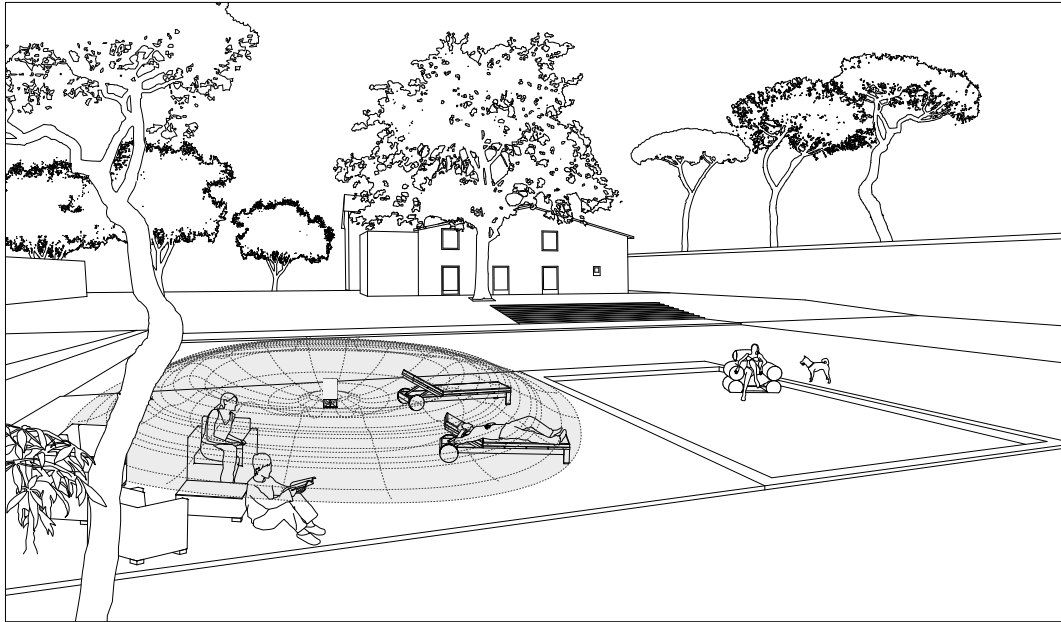

Anti-theft system: When installing the Cylinder outdoor, especially in public spaces, specifically designed anti-theft systems are available on demand to secure the module to the ground. In the case of outdoor installations on grass or soil proceed as follows:

- Screw the hook into the hole below the base, securing it with the lock-nut.
- Dig one hole, approx. 50 cm deep, and fill it with concrete for approx. 2/3 of its depth.
- Put hook into hole till the base sits properly on the ground.
- Let concrete dry and fill hole with soil.

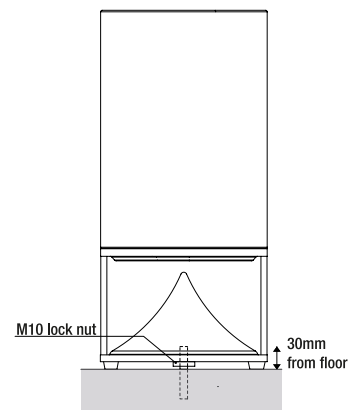
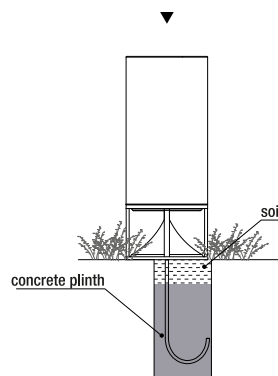
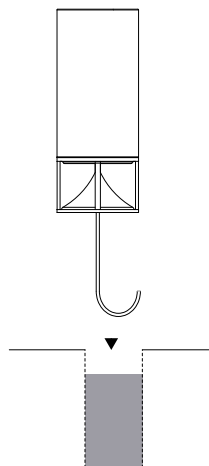
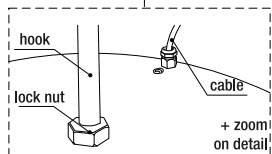
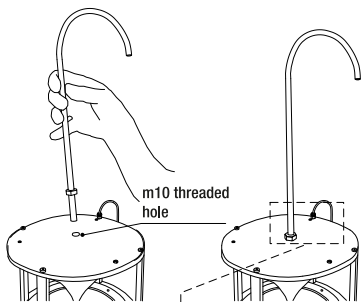

In the case of installations on hard floors, like stone or wood, it is recommended to fix a M10 threaded head on the ground on which to screw and unscrew the Cylinder through the appropriate threaded hole below the base, securing it with a proper locknut. Make sure the screw comes out 30 mm from the floor.

Maintenance and care: to keep your speakers beautiful as long as possible, we warmly recommend doing maintenance at least once a year. When not in use, sound modules should be appropriately covered or stored away; heavy duty protective covers are available from AS. Please refer to the General Manual for appropriate instructions and note that any departure from our recommendations on care and cleaning, or any evidence of misuse or damages from ordinary wear and tear, will void all warranty claims.

